



PRODUCTS CATALOG

ELECTRICAL ENCLOSURES & MODULAR CABINETS



20

exmweb.com

NEMA 4-12 ENCLOSURES

5412 ESEL

WATER, OIL & DUST TIGHT ENCLOSURES (WELDED MOUNTING FEET)

The 5412 ESEL water, oil & dust tight enclosures are used indoors or outdoors in areas where the enclosures may be subject to hosing or water coming from any direction, or for protection against dust, dirt or oil splashing. The 5412 ESEL are made of high quality 14 GA or 16 GA steel, with continuously welded corner seams. The opening has a curled lip around all sides to increase rigidity and prevent dripping water from entering the enclosure when the door is open. A high

quality, robotically poured-in-place, seamless gasket ensures a complete and durable water tight seal. A full length piano hinge with stainless steel pin permits 180 degrees opening. The hinge pin can be pulled out to remove the door. The externally mounted 1/4 turn locks, on 3 sides of the enclosure, permit positive closing and a larger surface area for instrument mounting. **Each enclosure comes complete with a 12 GA galvanized inner panel**, which is dou-

ble bent* for maximum rigidity and mounts on M8 welded studs. Enclosures are finished with heat fused powder paint, electrostatically applied on a pretreated base. Box is ANSI/ASA 61 smooth gray.

**CSA Certified / UL Listed
NEMA/EEMAC 4-12 / IP66**

**Refer to p.734 to validate
choice of substrate for the
application**

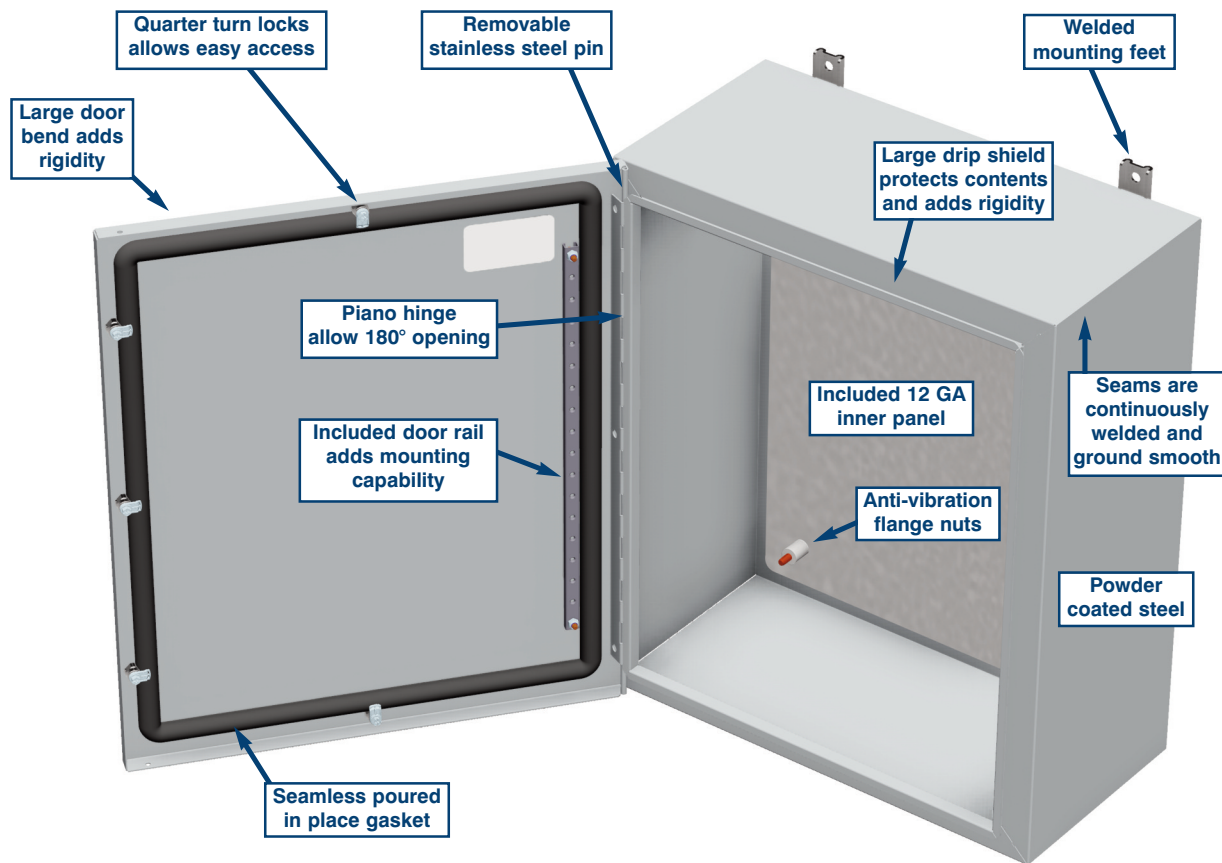

The 5412 ESEL -
98 stock sizes available

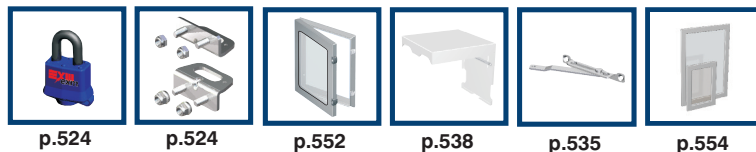

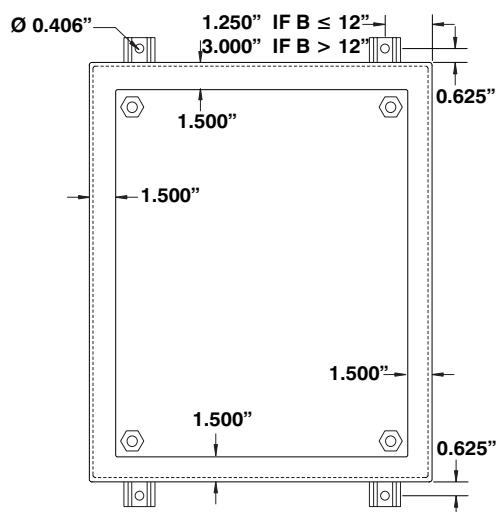
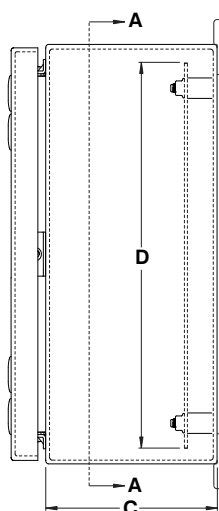
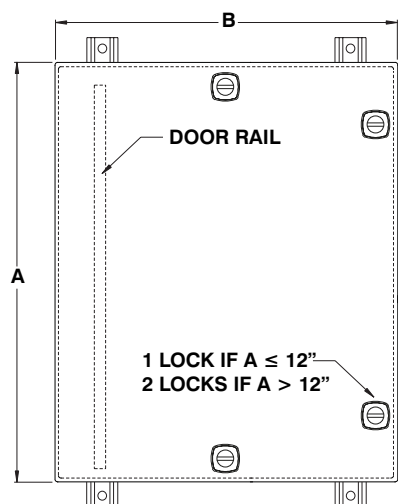

SECTION A-A

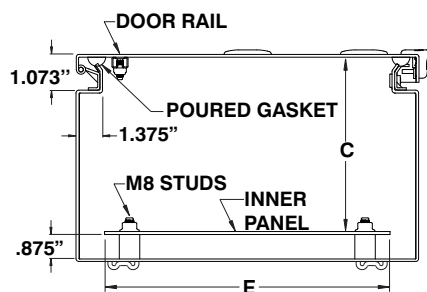

CATALOG NUMBER	DIMENSIONS					SHIP WGT LBS.
	A	B	C	D	E	
5412 ESEL121206	12	12	6	9	9	19
5412 ESEL122406	12	24	6	9	21	35
5412 ESEL161206	16	12	6	13	9	24
5412 ESEL161606	16	16	6	13	13	31
5412 ESEL162006	16	20	6	13	17	37
5412 ESEL122408	12	24	8	9	21	38
5412 ESEL161208	16	12	8	13	9	27
5412 ESEL161608	16	16	8	13	13	34
5412 ESEL162008	16	20	8	13	17	41
5412 ESEL161210	16	12	10	13	9	30

* Only panels with sides 20" or more are double bent.



p.556



p.538



p.603



p.625



p.565



p.534



NEMA 4-12 ENCLOSURES

5412 ESEL

WATER, OIL & DUST TIGHT ENCLOSURES (WELDED MOUNTING FEET)

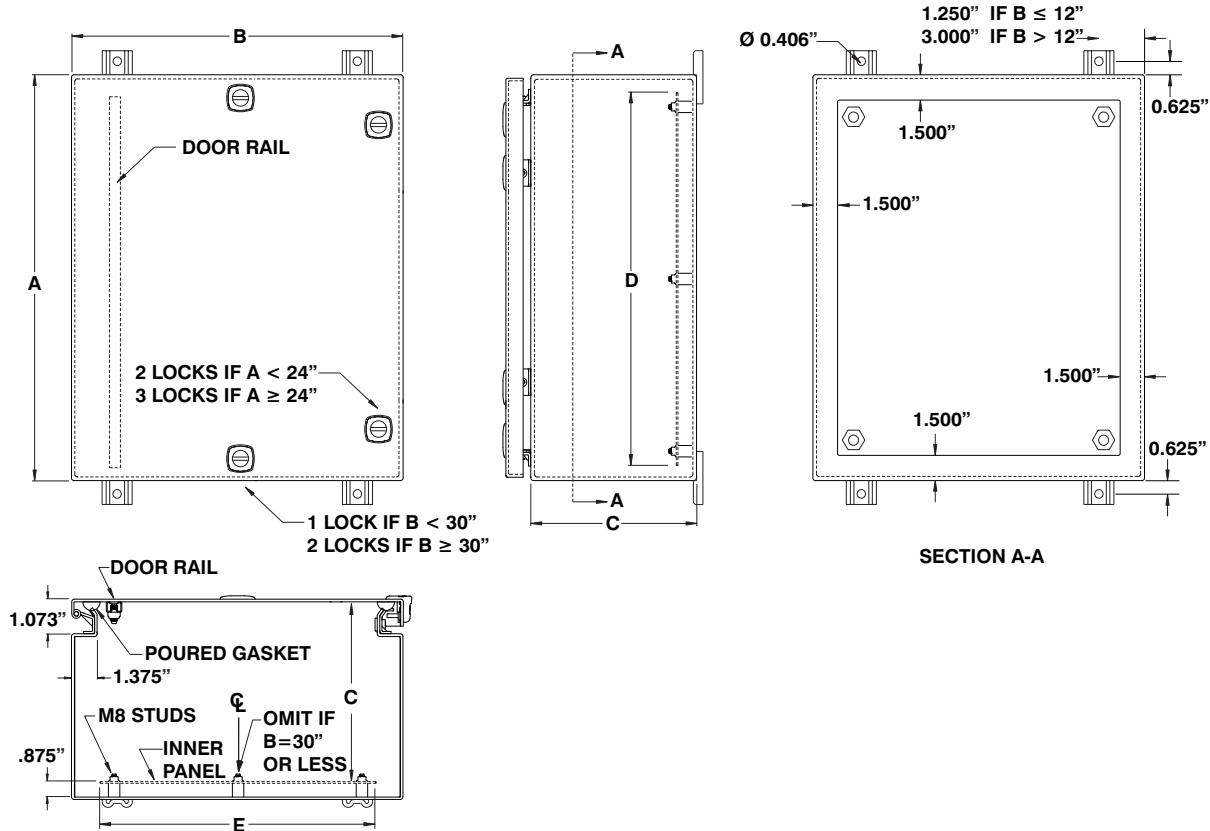

CATALOG NUMBER	DIMENSIONS					SHIP WGT LBS.
	A	B	C	D	E	
5412 ESEL201206	20	12	6	17	9	29
5412 ESEL201606	20	16	6	17	13	37
5412 ESEL202006	20	20	6	17	17	45
5412 ESEL202406	20	24	6	17	21	53
5412 ESEL241206	24	12	6	21	9	35
5412 ESEL241606	24	16	6	21	13	44
5412 ESEL242006	24	20	6	21	17	53
5412 ESEL242406	24	24	6	21	21	62
5412 ESEL301606	30	16	6	27	13	53
5412 ESEL302006	30	20	6	27	17	65
5412 ESEL302406	30	24	6	27	21	76
5412 ESEL362406	36	24	6	33	21	90
5412 ESEL363006	36	30	6	33	27	109
5412 ESEL201208	20	12	8	17	9	33
5412 ESEL201608	20	16	8	17	13	41
5412 ESEL202008	20	20	8	17	17	49
5412 ESEL202408	20	24	8	17	21	57
5412 ESEL241208	24	12	8	21	9	38
5412 ESEL241608	24	16	8	21	13	48
5412 ESEL242008	24	20	8	21	17	57
5412 ESEL242408	24	24	8	21	21	67
5412 ESEL243008	24	30	8	21	27	81
5412 ESEL301208	30	12	8	27	9	46
5412 ESEL301608	30	16	8	27	13	58
5412 ESEL302008	30	20	8	27	17	70
5412 ESEL302408	30	24	8	27	21	81
5412 ESEL303008	30	30	8	27	27	98
5412 ESEL303608	30	36	8	27	33	116
5412 ESEL362408	36	24	8	33	21	95
5412 ESEL363008	36	30	8	33	27	116

CATALOG NUMBER	DIMENSIONS					SHIP WGT LBS.
	A	B	C	D	E	
5412 ESEL363608	36	36	8	33	33	136
5412 ESEL201610	20	16	10	17	13	44
5412 ESEL202010	20	20	10	17	17	53
5412 ESEL241210	24	12	10	21	9	42
5412 ESEL242010	24	20	10	21	17	62
5412 ESEL242410	24	24	10	21	21	71
5412 ESEL302010	30	20	10	27	17	74
5412 ESEL302410	30	24	10	27	21	86
5412 ESEL303010	30	30	10	27	27	100
5412 ESEL362410	36	24	10	33	21	101
5412 ESEL363010	36	30	10	33	27	122
5412 ESEL201612	20	16	12	17	13	48
5412 ESEL202012	20	20	12	17	17	57
5412 ESEL202412	20	24	12	17	21	66
5412 ESEL242012	24	20	12	21	17	66
5412 ESEL242412	24	24	12	21	21	76
5412 ESEL302412	30	24	12	27	21	92
5412 ESEL303012	30	30	12	27	27	110
5412 ESEL362412	36	24	12	33	21	107
5412 ESEL363012	36	30	12	33	27	129
5412 ESEL363612	36	36	12	33	33	150
5412 ESEL242016	24	20	16	21	17	74
5412 ESEL242416	24	24	16	21	21	86
5412 ESEL302416	30	24	16	27	21	102
5412 ESEL362416	36	24	16	33	21	119
5412 ESEL363016	36	30	16	33	27	142
5412 ESEL302420	30	24	20	27	21	113
5412 ESEL363020	36	30	20	33	27	155
5412 ESEL302424	30	24	24	27	21	123

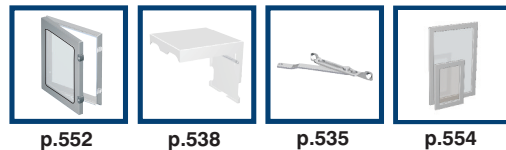

WATER, OIL & DUST TIGHT ENCLOSURES (WELDED MOUNTING FEET)

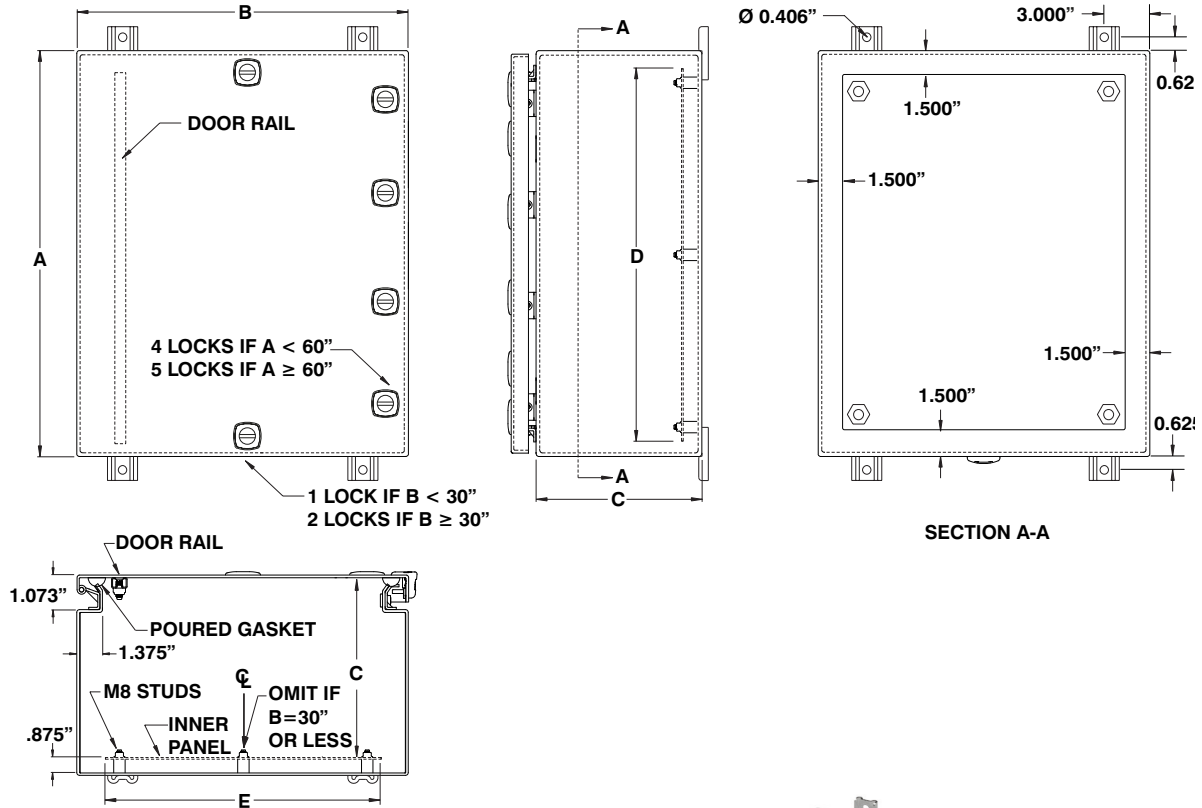

CATALOG NUMBER	DIMENSIONS					SHIP WGHT LBS.
	A	B	C	D	E	
5412 ESEL422408	42	24	8	39	21	110
5412 ESEL423008	42	30	8	39	27	133
5412 ESEL423608	42	36	8	39	33	156
5412 ESEL482408	48	24	8	45	21	124
5412 ESEL483008	48	30	8	45	27	150
5412 ESEL483608	48	36	8	45	33	177
5412 ESEL603608	60	36	8	57	33	218
5412 ESEL423010	42	30	10	39	27	140
5412 ESEL423610	42	36	10	39	33	164
5412 ESEL483010	48	30	10	45	27	158
5412 ESEL483610	48	36	10	45	33	185
5412 ESEL603610	60	36	10	58	33	227
5412 ESEL422412	42	24	12	39	21	118
5412 ESEL423012	42	30	12	39	27	147
5412 ESEL423612	42	36	12	39	33	172
5412 ESEL482412	48	24	12	45	21	138
5412 ESEL483612	48	36	12	45	33	193
5412 ESEL602412	60	24	12	57	21	169
5412 ESEL603612	60	36	12	57	33	236
5412 ESEL723012	72	30	12	69	27	240
5412 ESEL723612	72	36	12	69	33	279
5412 ESEL423616	42	36	16	39	33	187
5412 ESEL483616	48	36	16	45	33	210
5412 ESEL603616	60	36	16	57	13	255
5412 ESEL723016	72	30	16	69	27	260
5412 ESEL723616	72	36	16	69	33	301
5412 ESEL483620	48	36	20	45	33	226
5412 ESEL603620	60	36	20	57	33	274
5412 ESEL723020	72	30	20	69	27	280
5412 ESEL723024	72	30	24	69	27	300



Insulated box? To have your enclosure insulated, add suffix "TH"

i.e.: 5412 ESEL422408TH ← Insulated steel enclosure

